

5-Phase Stepping Motor and Driver Packages

CRK Series

Pulse Input Type
24 VDC Microstep Drive

5-phase stepping motor and driver packages with low-vibration, low-noise 24 VDC input microstep drive.
A new case-type compact driver that is installable on DIN rails has been added to the product lineup.



**Simple wiring with connectors.
Simple installation with DIN rails.
A new case-type compact driver has been added to the CRK series pulse input type product lineup.**



Compact Driver Compatible with DIN Rails

● Compact Case-type DC Power Supply Input Driver

This compact driver features dimensions of 35 mm (w) × 100 mm (h) × 70 mm (d). This contributes to space saving for the control box and equipment.

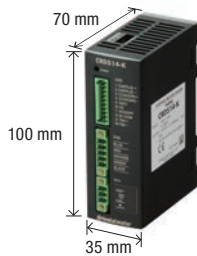

● Installable on DIN Rails

The driver can be installed directly on a DIN rail. No installation screws are required.

- Can be installed on DIN rails only.



● Easy Wiring

Wiring with connectors eliminates the need for special crimp tools, and makes wiring easy.

Low Vibration and Low Noise

● Low Vibration and Low Noise Achieved by Microstep Drive

The basic step angle of the motor can be divided into a maximum of 250 microstep angles without using any mechanical element such as a speed reduction mechanism. This reduces the vibration and noise of your equipment.

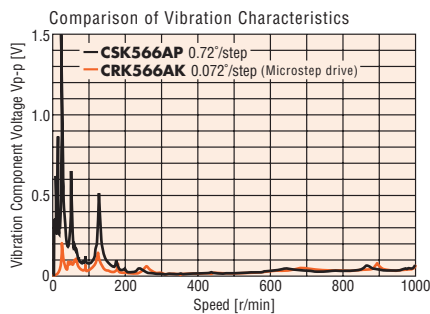

● Smooth Drive for Enhanced Ease of Use

Smooth drive control automatically implements microstep drive based on the same traveling amount and traveling speed used in the full step mode, without changing the pulse input settings.

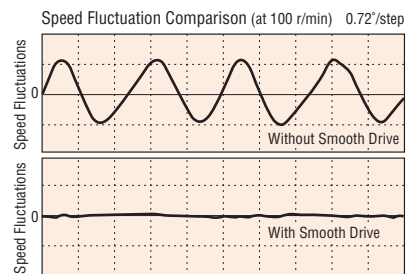

(RoHS) RoHS Directive-Compliant

The **CRK** Series conforms to the RoHS Directive that prohibits the use of 6 chemical substances including lead and cadmium.

CE Marking













This product has the CE Marking affixed under the EMC Directive based on the EN Standards.

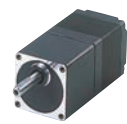

- The EMC value changes according to the wiring and layout. Therefore, the final check must be done with the product incorporated in the user's equipment.

Wide Variety

The motor and driver package comes in four motor frame sizes of 20 to 60 mm, as well as two geared motor types.

Type	Features	□20 mm	□28 mm	□42 mm	□60 mm	Driver
High-Torque Type	A high-torque motor generates higher torque of approximately 1.3~1.5 times compared with the conventional standard type motor.					
Standard Type	The basic model offering an optimal balance of torque, low vibration and noise reduction.					
Low Backlash	TH Geared Type					
	PS Geared Type					

Characteristics Comparison for Geared Motor

Geared Type	Features	Permissible Torque and Maximum Torque [N·m]	Backlash [arc minute]	Basic Resolution [deg/step]	Output Shaft Rotation Speed [r/min]
Low Backlash	 TH Geared (Spur gear mechanism)	4	60	0.024	500
	 PS Geared (Planetary gear mechanism)	Permissible Torque: 8 Maximum Torque: 20	35	0.0144	600

Note

● The values shown above must be used only as reference values to understand the differences of respective types. These values vary depending on the motor frame size and gear ratio.

System Configuration

An example of system a configuration with the **SG8030J** controller is shown below.

*1 Not supplied

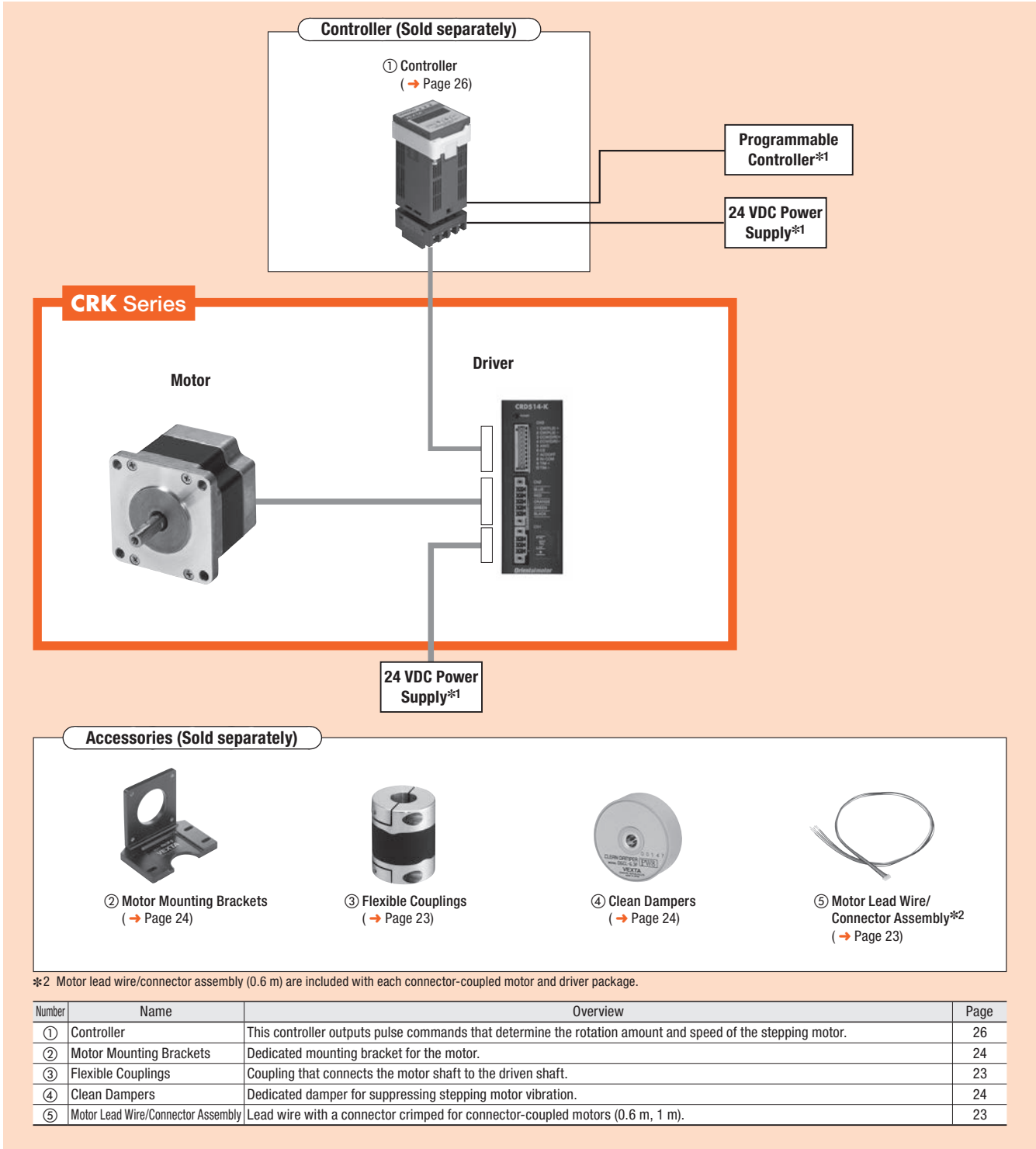

System Configuration Example

CRK Series	Sold Separately			
	Controller	Motor Mounting Bracket	Flexible Coupling	Clean Damper
CRK566BK	SG8030J-U	PAL2P-5	MCV190808	D6CL-8.0F

● The system configuration shown above is an example. Other combinations are available.

Product Number Code

Geared Type

CRK 5 2 3 P A K - T 7.2

① ② ③ ④ ⑤ ⑥ ⑦ ⑧ ⑨

①	Series Name	CRK: CRK Series
②	5-Phase	
③	Motor Frame Size	1: 20 mm 2: 28 mm 4: 42 mm 6: 60 mm
④	Motor Case Length	
⑤	Motor Classification	
⑥	Motor Shaft Type	A: Single Shaft B: Double Shaft
⑦	Power Supply Input	K: 24 VDC Input
⑧	Gear Type	T: TH Geared Type PS: PS Geared Type
⑨	Gear Ratio	

Product Line

High-Torque Type

Product Name (Single shaft)	Product Name (Double shaft)
CRK513PAK	CRK513PBK
CRK523PAK	CRK523PBK
CRK525PAK	CRK525PBK

Standard Type

Product Name (Single shaft)	Product Name (Double shaft)
CRK543AK	CRK543BK
CRK544AK	CRK544BK
CRK545AK	CRK545BK
CRK564AK	CRK564BK
CRK566AK	CRK566BK
CRK569AK	CRK569BK

TH Geared Type

Product Name (Single shaft)	Product Name (Double shaft)
CRK523PAK-T7.2	CRK523PBK-T7.2
CRK523PAK-T10	CRK523PBK-T10
CRK523PAK-T20	CRK523PBK-T20
CRK523PAK-T30	CRK523PBK-T30
CRK543AK-T3.6	CRK543BK-T3.6
CRK543AK-T7.2	CRK543BK-T7.2
CRK543AK-T10	CRK543BK-T10
CRK543AK-T20	CRK543BK-T20
CRK543AK-T30	CRK543BK-T30
CRK564AK-T3.6	CRK564BK-T3.6
CRK564AK-T7.2	CRK564BK-T7.2
CRK564AK-T10	CRK564BK-T10
CRK564AK-T20	CRK564BK-T20
CRK564AK-T30	CRK564BK-T30

PS Geared Type

Product Name (Single shaft)	Product Name (Double shaft)
CRK523PAK-PS5	CRK523PBK-PS5
CRK523PAK-PS7	CRK523PBK-PS7
CRK523PAK-PS10	CRK523PBK-PS10
CRK545AK-PS5	CRK545BK-PS5
CRK545AK-PS7	CRK545BK-PS7
CRK545AK-PS10	CRK545BK-PS10
CRK543AK-PS25	CRK543BK-PS25
CRK543AK-PS36	CRK543BK-PS36
CRK543AK-PS50	CRK543BK-PS50
CRK566AK-PS5	CRK566BK-PS5
CRK566AK-PS7	CRK566BK-PS7
CRK566AK-PS10	CRK566BK-PS10
CRK564AK-PS25	CRK564BK-PS25
CRK564AK-PS36	CRK564BK-PS36
CRK564AK-PS50	CRK564BK-PS50

The following items are included in each product.

Motor, Parallel Key*¹, Driver, Driver Connector,
Motor Lead Wire/Connector Assembly*², Operating Manual
*¹ Only for products with a key slot on the output shaft.
*² Only for connector-coupled motor.

High-Torque Type Frame Size 20 mm, 28 mm

Specifications (RoHS)



Product Name	Single Shaft	CRK513PAK*	CRK523PAK*	CRK525PAK*	
	Double Shaft	CRK513PBK*	CRK523PBK*	CRK525PBK*	
Maximum Holding Torque	N·m	0.0231	0.048	0.078	
Rotor Inertia	J: kg·m ²	1.6×10 ⁻⁷	9×10 ⁻⁷	18×10 ⁻⁷	
Rated Current	A/Phase	0.35			
Basic Step Angle	0.72°				
Power Supply Input	24 VDC±10% 0.7 A				
Excitation Mode	Microstep				
Mass	Motor	kg	0.05	0.11	0.2
	Driver	kg	0.12		
Dimensions No.	Motor	[1]		[2]	
	Driver	[1]			

How to read the specifications table → See below.

*Motor lead wire/connector assembly (0.6 m) are included with each connector-coupled motor and driver package.

Speed – Torque Characteristics

CRK513PAK/CRK513PBK

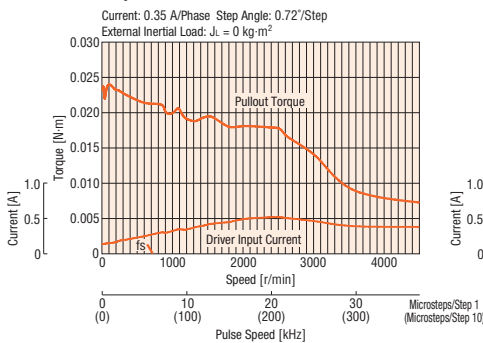

CRK523PAK/CRK523PBK

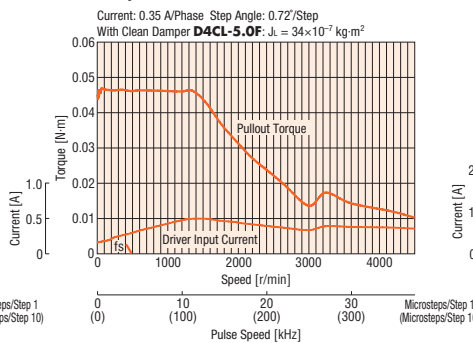

CRK525PAK/CRK525PBK

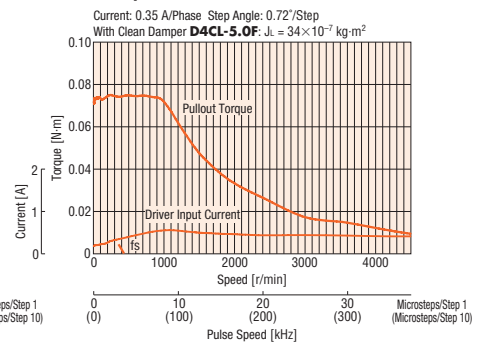

Note

- Depending on the driving conditions, a considerable amount of heat may be generated by the motor. Be sure to keep the motor case temperature at 100°C or less.
- The driver's automatic current cutback function at motor standstill reduces maximum holding torque by approximately 50%.

How to Read the Specifications Table

Max. Holding Torque	: The holding torque (5-Phase: 5-Phase excitation) is the maximum holding torque (holding force) the motor has when power (rated current) is being supplied but the motor shaft is not rotating. (With geared types, the permissible strength of the gear is also taken into account with the holding torque value.) The driver's automatic current cutback function at motor standstill reduces the max. holding torque by approximately 50%.
Permissible Torque	: The permissible torque represents the max. value limited by the mechanical strength of the output gear shaft when operated at a constant speed. For the TH geared type, make sure that the applied torque, including during acceleration and deceleration, does not exceed the permissible torque.
Maximum Torque	: This is the max. torque that can be applied to the gear output shaft during acceleration/deceleration such as when an inertial load is started and stopped. (PS geared only)

Standard Type Frame Size 42 mm, 60 mm

Specifications RoHS



Product Name	Single Shaft	CRK543AK	CRK544AK	CRK545AK	CRK564AK	CRK566AK	CRK569AK	
	Double Shaft	CRK543BK	CRK544BK	CRK545BK	CRK564BK	CRK566BK	CRK569BK	
Maximum Holding Torque	N·m	0.13	0.18	0.24	0.42	0.83	1.66	
Rotor Inertia	J: kg·m ²	35×10 ⁻⁷	54×10 ⁻⁷	68×10 ⁻⁷	175×10 ⁻⁷	280×10 ⁻⁷	560×10 ⁻⁷	
Rated Current	A/Phase	0.75			1.4			
Basic Step Angle		0.72°						
Power Supply Input		24 VDC±10% 1.4 A			24 VDC±10% 2.5 A			
Excitation Mode		Microstep						
Mass	Motor	kg	0.21	0.27	0.35	0.6	0.8	1.3
	Driver	kg	0.12					
Dimensions No.	Motor		[3]			[4]		
	Driver		[11]					

How to read specifications table → Page 6

Speed – Torque Characteristics

CRK543AK/CRK543BK

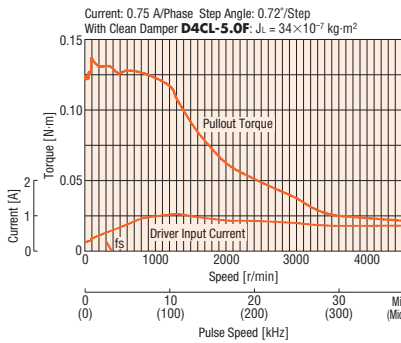

CRK544AK/CRK544BK

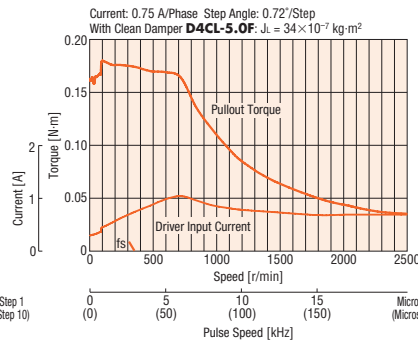

CRK545AK/CRK545BK

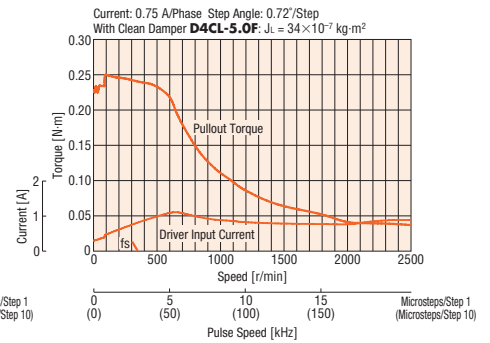

CRK564AK/CRK564BK

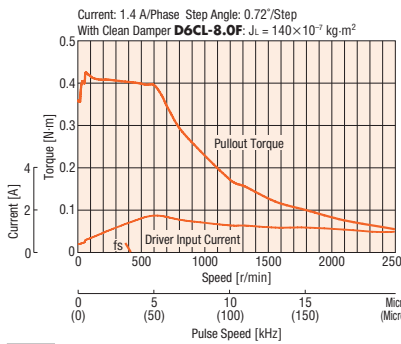

CRK566AK/CRK566BK

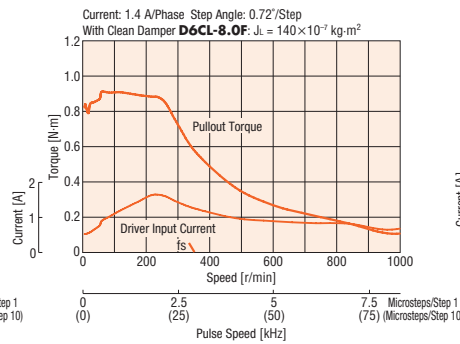

CRK569AK/CRK569BK

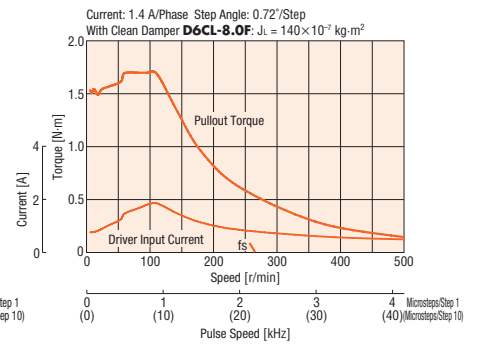

Note

- Depending on the driving conditions, a considerable amount of heat may be generated by the motor. Be sure to keep the motor case temperature at 100°C or less.
- The driver's automatic current cutback function at motor standstill reduces maximum holding torque by approximately 50%.

TH Geared Type Frame Size 28 mm

Specifications RoHS



Product Name	Single Shaft	CRK523PAK-T7.2*	CRK523PAK-T10*	CRK523PAK-T20*	CRK523PAK-T30*
	Double Shaft	CRK523PBK-T7.2*	CRK523PBK-T10*	CRK523PBK-T20*	CRK523PBK-T30*
Maximum Holding Torque	N·m	0.2	0.3	0.4	0.5
Rotor Inertia	J: kg·m ²	9×10^{-7}			
Rated Current	A/Phase	0.35			
Basic Step Angle		0.1°	0.072°	0.036°	0.024°
Gear Ratio		7.2	10	20	30
Permissible Torque	N·m	0.2	0.3	0.4	0.5
Backlash	arc minute (degrees)	60 (1°)			
Permissible Speed Range	r/min	0~416	0~300	0~150	0~100
Power Supply Input		24 VDC±10% 0.7 A			
Excitation Mode		Microstep			
Mass	Motor	kg		0.17	
	Driver	kg		0.12	
Dimensions No.	Motor			[5]	
	Driver			[11]	

How to read specifications table → Page 6

*Motor lead wire/connector assembly (0.6 m) are included with each connector-coupled motor and driver package.

Note

● The rotation direction of the motor and that of the gear output shaft are the opposite for the gear ratios 7.2 and 10. It is the same for the 20 and 30 gear ratios.

Speed – Torque Characteristics

CRK523PAK-T7.2/CRK523PBK-T7.2

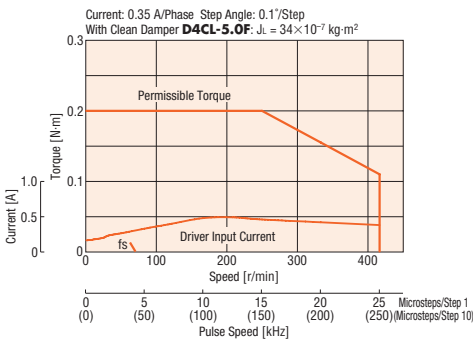

CRK523PAK-T10/CRK523PBK-T10

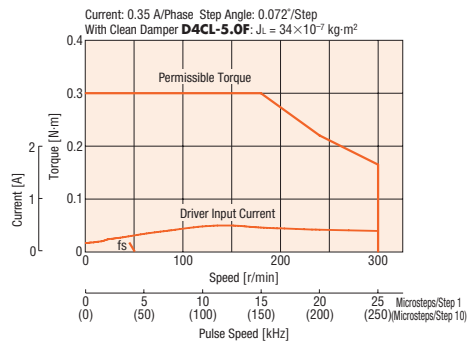

CRK523PAK-T20/CRK523PBK-T20

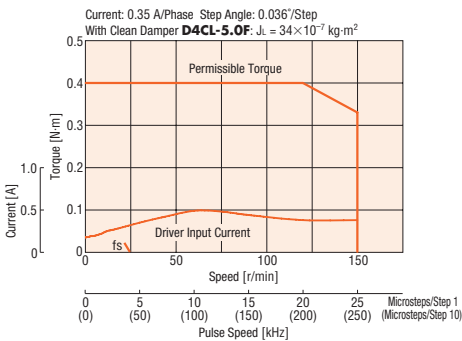

CRK523PAK-T30/CRK523PBK-T30

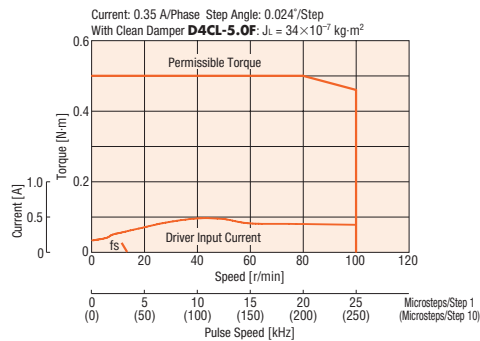

Note

- Depending on the driving conditions, a considerable amount of heat may be generated by the motor. Be sure to keep the motor case temperature at 100°C or less.
- The driver's automatic current cutback function at motor standstill reduces maximum holding torque by approximately 50%.

TH Geared Type Frame Size 42 mm

Specifications (RoHS)



Product Name	Single Shaft	CRK543AK-T3.6	CRK543AK-T7.2	CRK543AK-T10	CRK543AK-T20	CRK543AK-T30
	Double Shaft	CRK543BK-T3.6	CRK543BK-T7.2	CRK543BK-T10	CRK543BK-T20	CRK543BK-T30
Maximum Holding Torque	N·m	0.35	0.7	1	1.5	
Rotor Inertia	J: kg·m ²	35×10 ⁻⁷				
Rated Current	A/Phase	0.75				
Basic Step Angle		0.2°	0.1°	0.072°	0.036°	0.024°
Gear Ratio		3.6	7.2	10	20	30
Permissible Torque	N·m	0.35	0.7	1	1.5	
Backlash	arc minute (degrees)	45 (0.75°)	25 (0.417°)		15 (0.25°)	
Permissible Speed Range	r/min	0~500	0~250	0~180	0~90	0~60
Power Supply Input		24 VDC±10% 1.4 A				
Excitation Mode		Microstep				
Mass	Motor	kg			0.35	
	Driver	kg			0.12	
Dimensions No.	Motor				[6]	
	Driver				[11]	

How to read specifications table → Page 6

Note

- The rotation direction of the motor and that of the gear output shaft are the same for the gear ratios 3.6, 7.2 and 10. It is the opposite for the 20 and 30 gear ratios.

Speed – Torque Characteristics

CRK543AK-T3.6/CRK543BK-T3.6

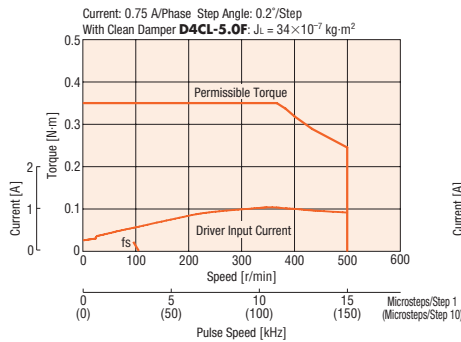

CRK543AK-T7.2/CRK543BK-T7.2

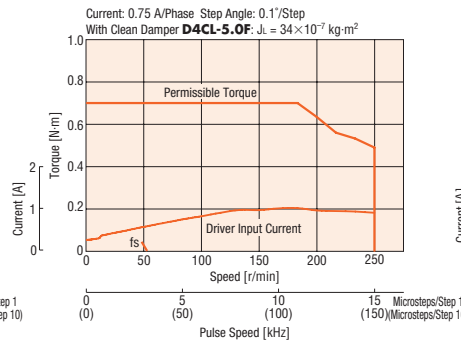

CRK543AK-T10/CRK543BK-T10

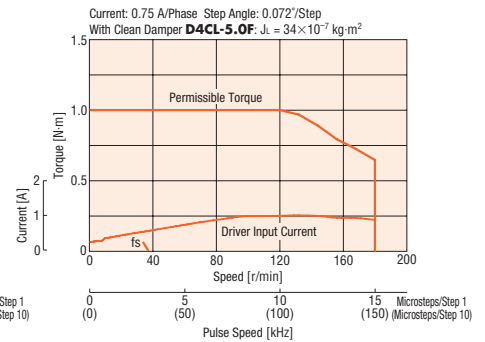

CRK543AK-T20/CRK543BK-T20

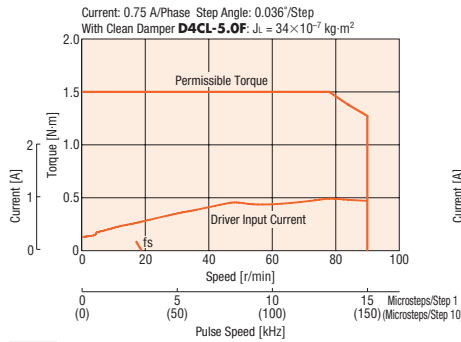

CRK543AK-T30/CRK543BK-T30

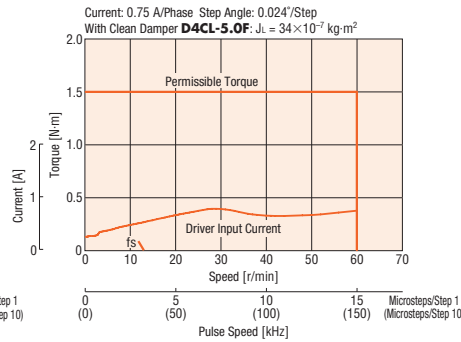

Note

- Depending on the driving conditions, a considerable amount of heat may be generated by the motor. Be sure to keep the motor case temperature at 100°C or less.
- The driver's automatic current cutback function at motor standstill reduces maximum holding torque by approximately 50%.

TH Geared Type Frame Size 60 mm

Specifications RoHS



Product Name	Single Shaft	CRK564AK-T3.6	CRK564AK-T7.2	CRK564AK-T10	CRK564AK-T20	CRK564AK-T30
	Double Shaft	CRK564BK-T3.6	CRK564BK-T7.2	CRK564BK-T10	CRK564BK-T20	CRK564BK-T30
Maximum Holding Torque	N·m	1.25	2.5	3	3.5	4
Rotor Inertia	J: kg·m ²	175×10 ⁻⁷				
Rated Current	A/Phase	1.4				
Basic Step Angle		0.2°	0.1°	0.072°	0.036°	0.024°
Gear Ratio		3.6	7.2	10	20	30
Permissible Torque	N·m	1.25	2.5	3	3.5	4
Backlash	arc minute (degrees)	35 (0.584°)	15 (0.25°)		10 (0.167°)	
Permissible Speed Range	r/min	0~500	0~250	0~180	0~90	0~60
Power Supply Input		24 VDC±10% 2.5 A				
Excitation Mode		Microstep				
Mass	Motor			0.95		
	Driver			0.12		
Dimensions No.	Motor			7		
	Driver			11		

How to read specifications table → Page 6

Note

- The rotation direction of the motor and that of the gear output shaft are the same for the gear ratios 3.6, 7.2 and 10. It is the opposite for the 20 and 30 gear ratios.

Speed – Torque Characteristics

CRK564AK-T3.6/CRK564BK-T3.6

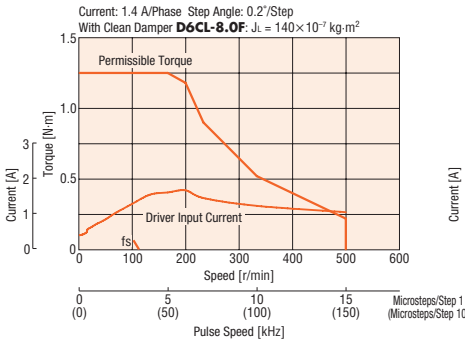

CRK564AK-T7.2/CRK564BK-T7.2

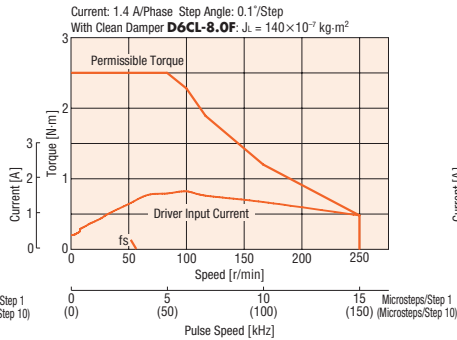

CRK564AK-T10/CRK564BK-T10

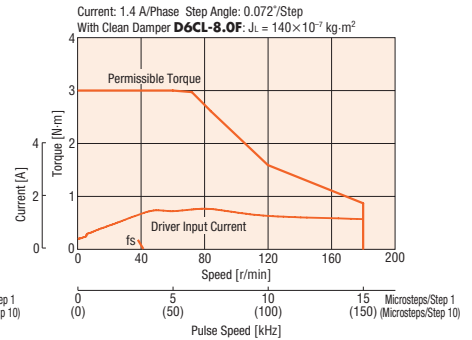

CRK564AK-T20/CRK564BK-T20

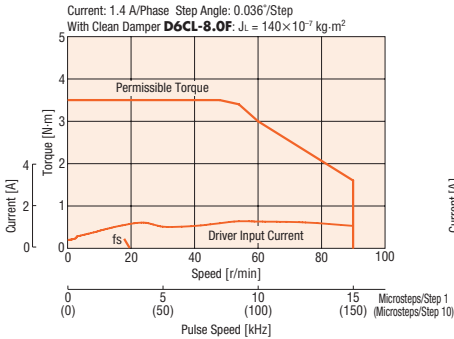

CRK564AK-T30/CRK564BK-T30

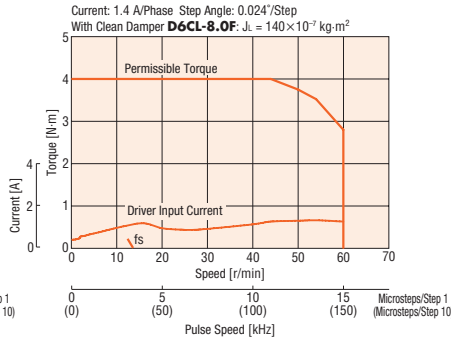

Note

- Depending on the driving conditions, a considerable amount of heat may be generated by the motor. Be sure to keep the motor case temperature at 100°C or less.
- The driver's automatic current cutback function at motor standstill reduces maximum holding torque by approximately 50%.

PS Geared Type Frame Size 28 mm

Specifications (RoHS)



Product Name	Single Shaft	CRK523PAK-PS5*1	CRK523PAK-PS7*1	CRK523PAK-PS10*1
	Double Shaft	CRK523PBK-PS5*1	CRK523PBK-PS7*1	CRK523PBK-PS10*1
Maximum Holding Torque	N·m	0.2	0.3	0.4
Rotor Inertia	J: kg·m ²	9×10 ⁻⁷		
Rated Current	A/Phase	0.35		
Basic Step Angle		0.144°	0.1°	0.072°
Gear Ratio		5	7.2	10
Permissible Torque	N·m	0.2	0.3	0.4
Maximum Torque*2	N·m	0.5		
Backlash	arc minute (degrees)	35 (0.59°)		
Permissible Speed Range	r/min	0~600	0~416	0~300
Power Supply Input		24 VDC±10% 0.7 A		
Excitation Mode		Microstep		
Mass	Motor	kg		
	Driver	kg		
Dimensions No.	Motor	[8]		
	Driver	[11]		

How to read specifications table → Page 6

*1 Motor lead wire/connector assembly (0.6 m) are included with each connector-coupled motor and driver package.

*2 The maximum torque value is for the gear. For the geared motor output torque, refer to the speed – torque characteristics.

Note

- The rotation direction of the motor and that of the gear output shaft are the same.

Speed – Torque Characteristics

CRK523PAK-PS5/CRK523PBK-PS5

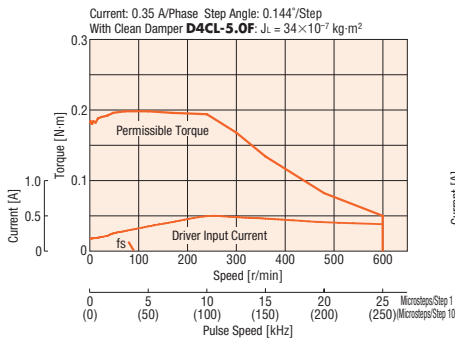

CRK523PAK-PS7/CRK523PBK-PS7

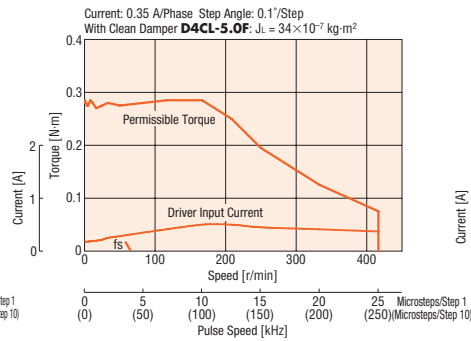

CRK523PAK-PS10/CRK523PBK-PS10

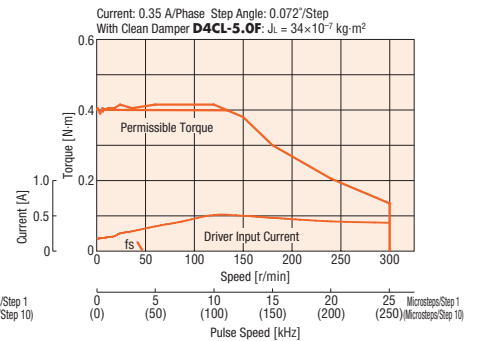

Note

- Depending on the driving conditions, a considerable amount of heat may be generated by the motor. Be sure to keep the motor case temperature at 100°C or less.
- The driver's automatic current cutback function at motor standstill reduces maximum holding torque by approximately 50%.

PS Geared Type Frame Size 42 mm

Specifications (RoHS)



Product Name	Single Shaft	CRK545AK-PS5	CRK545AK-PS7	CRK545AK-PS10	CRK543AK-PS25	CRK543AK-PS36	CRK543AK-PS50
	Double Shaft	CRK545BK-PS5	CRK545BK-PS7	CRK545BK-PS10	CRK543BK-PS25	CRK543BK-PS36	CRK543BK-PS50
Maximum Holding Torque	N·m	1	1.5	2.5	2.5	3	3
Rotor Inertia	J: kg·m ²	68×10 ⁻⁷			35×10 ⁻⁷		
Rated Current	A/Phase	0.75					
Basic Step Angle		0.144°	0.1°	0.072°	0.0288°	0.02°	0.0144°
Gear Ratio		5	7.2	10	25	36	50
Permissible Torque	N·m	1	1.5	2.5	2.5	3	3
Maximum Torque*	N·m	1.5	2	3	3	6	6
Backlash	arc minute (degrees)	25 (0.42°)					
Permissible Speed Range	r/min	0~600	0~416	0~300	0~120	0~83	0~60
Power Supply Input		24 VDC±10% 1.4 A					
Excitation Mode		Microstep					
Mass	Motor	0.58			0.59		
	Driver	0.12			0.12		
Dimensions No.	Motor	[9]					
	Driver	[11]					

How to read specifications table → Page 6

*The maximum torque value is for the gear. For the geared motor output torque, refer to the speed – torque characteristics.

Note

- The rotation direction of the motor and that of the gear output shaft are the same.

Speed – Torque Characteristics

CRK545AK-PS5/CRK545BK-PS5

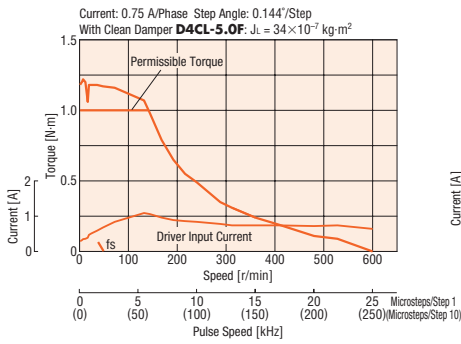

CRK545AK-PS7/CRK545BK-PS7

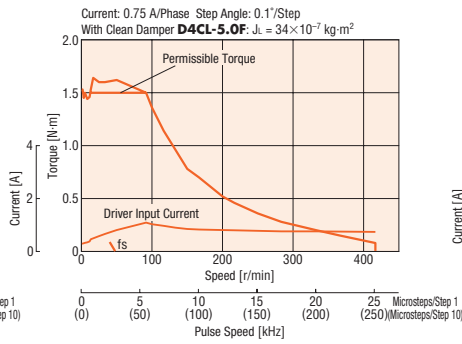

CRK545AK-PS10/CRK545BK-PS10

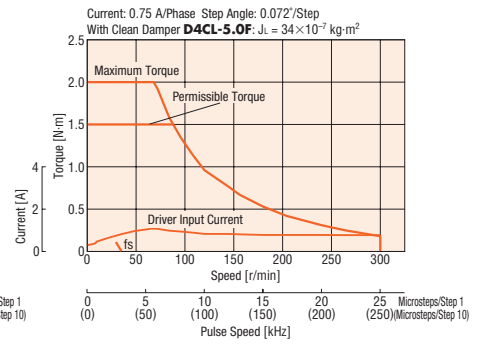

CRK543AK-PS25/CRK543BK-PS25

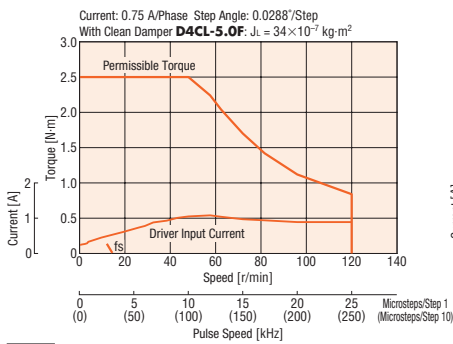

CRK543AK-PS36/CRK543BK-PS36

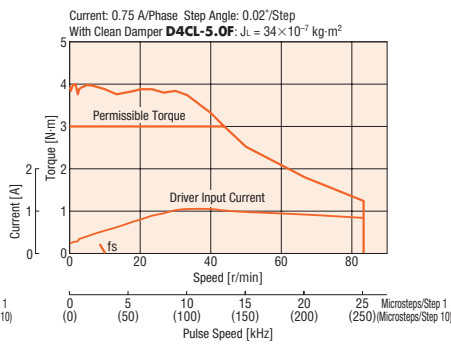

CRK543AK-PS50/CRK543BK-PS50

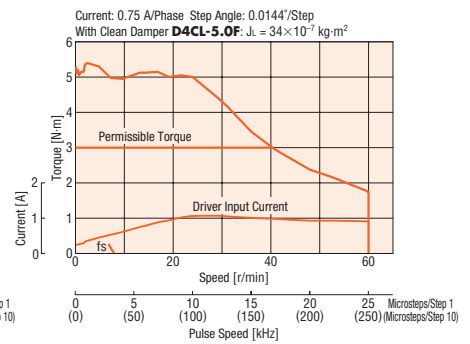

Note

- Depending on the driving conditions, a considerable amount of heat may be generated by the motor. Be sure to keep the motor case temperature at 100°C or less.
- The driver's automatic current cutback function at motor standstill reduces maximum holding torque by approximately 50%.

PS Geared Type Frame Size 60 mm

Specifications RoHS



Product Name	Single Shaft	CRK566AK-PS5	CRK566AK-PS7	CRK566AK-PS10	CRK564AK-PS25	CRK564AK-PS36	CRK564AK-PS50
	Double Shaft	CRK566BK-PS5	CRK566BK-PS7	CRK566BK-PS10	CRK564BK-PS25	CRK564BK-PS36	CRK564BK-PS50
Maximum Holding Torque	N·m	3.5	4	5	8		
Rotor Inertia	J: kg·m ²	280×10 ⁻⁷			175×10 ⁻⁷		
Rated Current	A/Phase	1.4					
Basic Step Angle		0.144°	0.1°	0.072°	0.0288°	0.02°	0.0144°
Gear Ratio		5	7.2	10	25	36	50
Permissible Torque	N·m	3.5	4	5	8		
Maximum Torque*	N·m	7	9	11	16	20	
Backlash	arc minute (degrees)	15 (0.25°)					
Permissible Speed Range	r/min	0~600	0~416	0~300	0~120	0~83	0~60
Power Supply Input		24 VDC±10% 2.5 A					
Excitation Mode		Microstep					
Mass	Motor	1.3			1.4		
	Driver	0.12					
Dimensions No.	Motor	10					
	Driver	11					

How to read specifications table → Page 6

*The maximum torque value is for the gear. For the geared motor output torque, refer to the speed – torque characteristics.

Note

- The rotation direction of the motor and that of the gear output shaft are the same.

Speed – Torque Characteristics

CRK566AK-PS5/CRK566BK-PS5

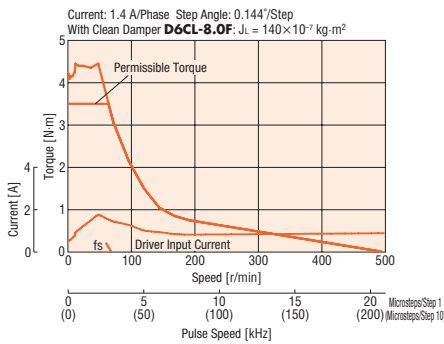

CRK566AK-PS7/CRK566BK-PS7

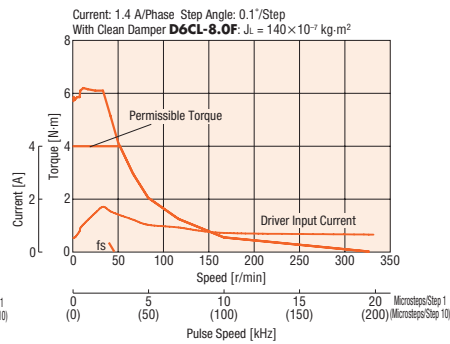

CRK566AK-PS10/CRK566BK-PS10

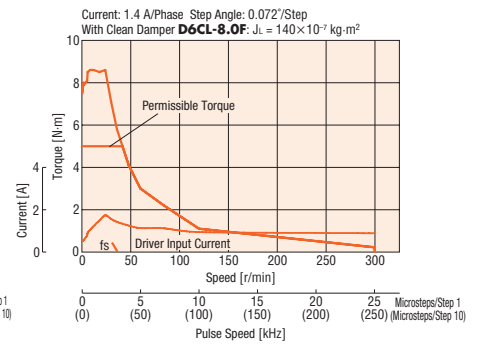

CRK564AK-PS25/CRK564BK-PS25

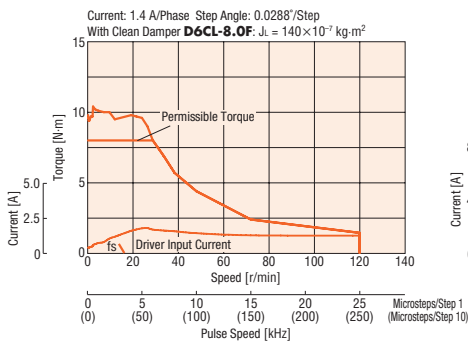

CRK564AK-PS36/CRK564BK-PS36

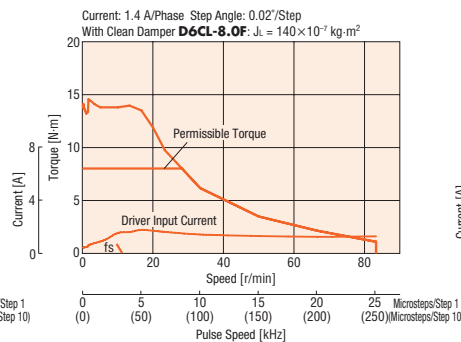

CRK564AK-PS50/CRK564BK-PS50

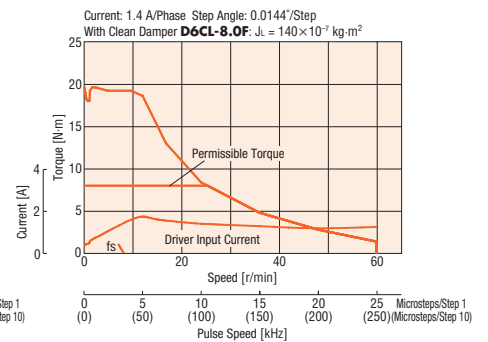

Note

- Depending on the driving conditions, a considerable amount of heat may be generated by the motor. Be sure to keep the motor case temperature at 100°C or less.
- The driver's automatic current cutback function at motor standstill reduces maximum holding torque by approximately 50%.

Driver Specifications

	Max. Input Pulse Frequency	Line driver output by programmable controller: 500 kHz (When the pulse duty is 50%) Open-collector output by programmable controller: 250 kHz (When the pulse duty is 50%)
Input Signals	CW Pulse Signal (Pulse signal)	CW Direction Operation Command Pulse Signal (Operation command pulse signal when in 1-pulse input mode) Negative Logic Pulse Input Pulse Width 1 μs min., Pulse Rise and Fall Time 2 μs max. Pulse Duty 50% max. The motor rotates one step when the pulse input is switched from "ON" → "OFF."
	CCW Pulse Signal (The rotation direction signal)	CCW Direction Operation Command Pulse Signal (Rotation direction signal when in 1-pulse input mode – photocoupler "ON": CW, photocoupler "OFF": CCW) Negative Logic Pulse Input Pulse Width 1 μs min., Pulse Rise and Fall Time 2 μs max. Pulse Duty 50% max. The motor rotates one step when the pulse input is switched from "ON" → "OFF."
	All Windings OFF Signal	When the signal is "photocoupler ON," the output current to the motor is cut off and the motor shaft can be rotated manually. When the signal is "photocoupler OFF," the output current is supplied to the motor.
	Step Angle Select Signal	When the signal is photocoupler "OFF," the step angle set by SW1 is selected; when the signal is photocoupler "ON," the basic step angle is selected.
	Current Cutback Release Signal	When the signal is "photocoupler ON," the automatic current cutback function is not activated even after the motor stops. When the signal is "photocoupler OFF," the automatic current cutback function is activated after the motor stops (after approximately 100 ms).
Output Signals	Excitation Timing Signal	Outputs signals when the excitation sequence is at STEP "0." (Photocoupler "ON") Example: 0.72°/Step (Microsteps/Step 1): Signal is output every 10 pulses 0.072°/Step (Microsteps/Step 10): Signal is output every 100 pulses.
Functions		Smooth Drive, Automatic Current Cutback, Step Angle Select, Pulse Input Mode Switch, All Windings Off, Excitation Timing
Cooling Method		Natural Cooling Method

General Specifications

Specifications		Motor	Driver
Insulation Class		Class B (130°C)	—
Insulation Resistance		The measured value is 100 MΩ or min. when a 500 VDC megger is applied between the windings and the case under normal ambient temperature and humidity.	—
Dielectric Strength		No abnormality is judged even with application of 1.5 kV* at 50 Hz or 60 Hz between the windings and the case for 1 minute under normal ambient temperature and humidity. *CRK54□: 1.0 kV CRK513P, CRK52□P : 0.5 kV	—
Operating Environment (In operation)	Ambient Temperature	−10~+50°C (non-freezing)	0~+40°C (non-freezing)
	Ambient Humidity	85% max. (non-condensing)	
	Atmosphere	Use in an area without corrosive gases or dust. The product should not be exposed to water, oil or other liquids.	
Temperature Rise		Winding temperature rise is 80°C max. (measured by the resistance change method) at the rated current, at standstill, and 5-phases energized.	—
Stop Position Accuracy*1		±3 arc minutes (±0.05°), CRK513P ±10 arc minutes (±0.17°)	—
Shaft Runout		0.05 T.I.R. (mm)*4	—
Radial Play*2		0.025 mm max. of 5 N	—
Axial Play*3		0.075 mm max. of 10 N	—
Concentricity		0.075 T.I.R. (mm)*4	—
Perpendicularity		0.075 T.I.R. (mm)*4	—

*1 This value is for full step under no load. (The value changes with the size of the load.)

*2 Radial Play: Displacement in shaft position in the radial direction when 5 N load is applied in the vertical direction to the tip of the motor's shaft.

*3 Axial Play: Displacement in shaft position in the axial direction when a 10 N load is applied to the motor's shaft in the axial direction.

*4 T.I.R. (Total Indicator Reading): The total dial gauge reading when the measurement section is rotated one revolution centered on the reference axis center.

Note

● Do not measure insulation resistance or perform the dielectric strength test while the motor and driver are connected.

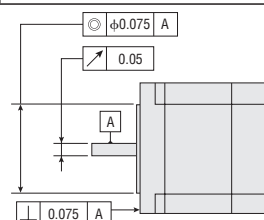

Permissible Overhung Load and Permissible Thrust Load

Type	Product Name	Permissible Overhung Load (Distance from Shaft End mm)					Permissible Thrust Load
		0	5	10	15	20	
High-Torque Type Standard Type	CRK513P □ K	12	15	–	–	–	Motor Self-Weight max.
	CRK523P □ K CRK525P □ K	25	34	52	–	–	
	CRK543 □ K CRK544 □ K CRK545 □ K	20	25	34	52	–	
	CRK564 □ K CRK566 □ K CRK569 □ K	63	75	95	130	190	
TH Geared Type	CRK523P □ K-T7.2 CRK523P □ K-T10 CRK523P □ K-T20 CRK523P □ K-T30	15	17	20	23	–	10
	CRK543 □ K-T3.6 CRK543 □ K-T7.2 CRK543 □ K-T10 CRK543 □ K-T20 CRK543 □ K-T30	10	14	20	30	–	15
	CRK564 □ K-T3.6 CRK564 □ K-T7.2 CRK564 □ K-T10 CRK564 □ K-T20 CRK564 □ K-T30	70	80	100	120	150	40
PS Geared Type	CRK523P □ K-PS5 CRK523P □ K-PS7 CRK523P □ K-PS10	45	60	80	100	–	20
	CRK545 □ K-PS5 CRK545 □ K-PS7 CRK545 □ K-PS10	73	84	100	123	–	50
	CRK543 □ K-PS25 CRK543 □ K-PS36 CRK543 □ K-PS50	109	127	150	184	–	50
	CRK566 □ K-PS5	200	220	250	280	320	100
	CRK566 □ K-PS7 CRK566 □ K-PS10	250	270	300	340	390	100
	CRK564 □ K-PS25 CRK564 □ K-PS36 CRK564 □ K-PS50	330	360	400	450	520	100

● Either **A** or **B** indicating the motor shaft type is entered where the box □ is located within the product name.

Dimensions (Unit = mm)

Motors

High-Torque Type

1 20 mm

Product Name	Motor Product Name	Mass kg	CAD
CRK513PAK	PK513PA	0.05	B316
CRK513PBK	PK513PB		

Motor lead wire/connector assembly (0.6 m) are included with the motor and driver package.
UL Style 3265, AWG 24

If you are purchasing only a motor for maintenance purposes, etc., motor lead wire/connector assembly and connector will not be supplied.

Please provide separately. → Page 23

● Applicable Connector

Connector Housing: 51065-0500 (MOLEX)

Contact: 50212-8100 (MOLEX)

Crimp Tool: 57176-5000 (MOLEX)

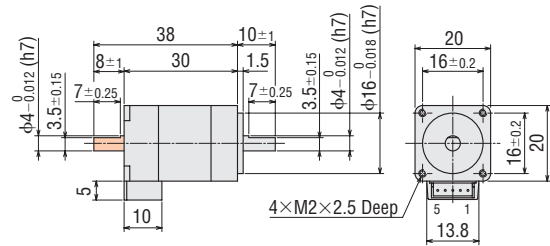

2 28 mm

Product Name	Motor Product Name	L1	L2	Mass kg	CAD
CRK523PAK	PK523P□A	32	—	0.11	B359
CRK523PBK	PK523P□B		42		
CRK525PAK	PK525P□A	51.5	—	0.2	B360
CRK525PBK	PK525P□B		61.5		

Motor lead wire/connector assembly (0.6 m) are included with the motor and driver package.
UL Style 3265, AWG 24

If you are purchasing only a motor for maintenance purposes, etc., motor lead wire/connector assembly and connector will not be supplied.

Please provide separately. → Page 23

● Applicable Connector

Connector Housing: 51065-0500 (MOLEX)

Contact: 50212-8100 (MOLEX)

Crimp Tool: 57176-5000 (MOLEX)

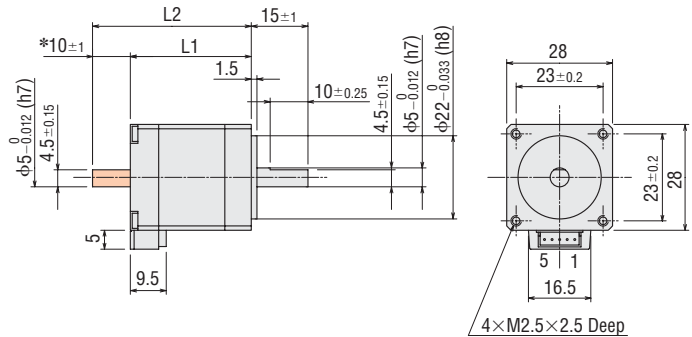

*The length of the shaft flat on the double shaft model is 10 ± 0.25 .

Standard Type

3 42 mm

Product Name	Motor Product Name	L1	L2	Mass kg	CAD
CRK543AK	PK543NAW	33	—	0.21	B068
CRK543BK	PK543NBW		48		
CRK544AK	PK544NAW	39	—	0.27	B069
CRK544BK	PK544NBW		54		
CRK545AK	PK545NAW	47	—	0.35	B070
CRK545BK	PK545NBW		62		

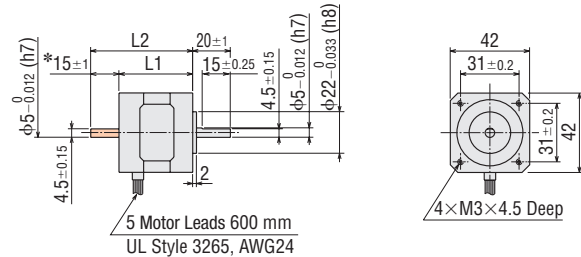

*The length of the shaft flat on the double shaft model is 15 ± 0.25 .

4 60 mm

Product Name	Motor Product Name	L1	L2	Mass kg	CAD
CRK564AK	PK564NAW	46.5	—	0.6	B071
CRK564BK	PK564NBW		69.5		
CRK566AK	PK566NAW	57.5	—	0.8	B072
CRK566BK	PK566NBW		80.5		
CRK569AK	PK569NAW	87	—	1.3	B073
CRK569BK	PK569NBW		110		

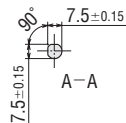
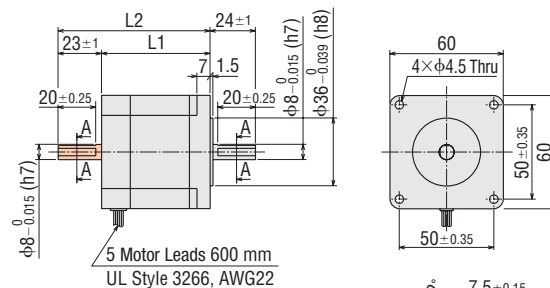

● These dimensions are for double shaft models. For single shaft models, ignore the  areas.

◆ TH Geared Type

5 28 mm

Product Name	Motor Product Name	Gear Ratio	Mass kg	CAD
CRK523PAK-T	PK523PA-T	7.2, 10, 20, 30	0.17	B361
CRK523PBK-T	PK523PB-T			

Motor lead wire/connector assembly (0.6 m) are included with the motor and driver package.

UL Style 3265, AWG 24

If you are purchasing only a motor for maintenance purposes, etc., motor lead wire/connector assembly and connector will not be supplied. Please provide separately. → Page 23

● Applicable Connector

Connector Housing: 51065-0500 (MOLEX)

Contact: 50212-8100 (MOLEX)

Crimp Tool: 57176-5000 (MOLEX)

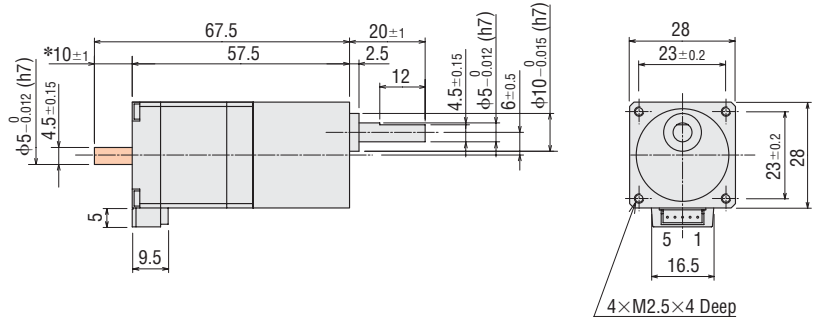

*The length of the shaft flat on the double shaft model is 10±0.25.

6 42 mm

Product Name	Motor Product Name	Gear Ratio	Mass kg	CAD
CRK543AK-T	PK543AW-T	3.6, 7.2, 10, 20, 30	0.35	B183
CRK543BK-T	PK543BW-T			

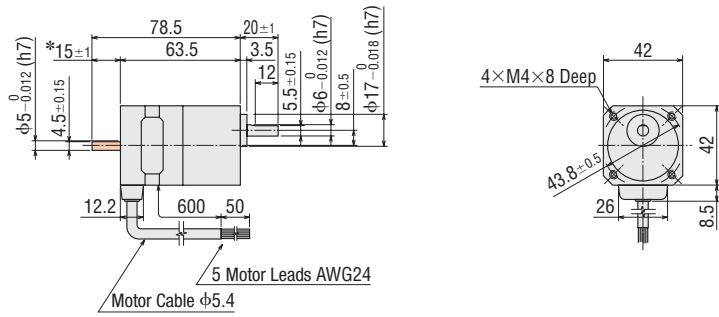

*The length of the shaft flat on the double shaft model is 15±0.25.

7 60 mm

Product Name	Motor Product Name	Gear Ratio	Mass kg	CAD
CRK564AK-T	PK564AW-T	3.6, 7.2, 10, 20, 30	0.95	B187
CRK564BK-T	PK564BW-T			

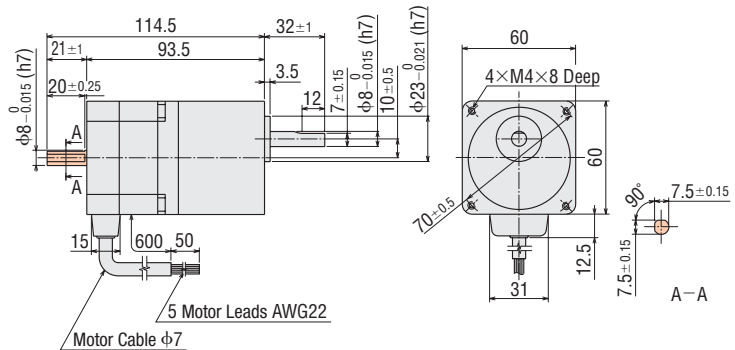

◆ PS Geared Type

8 28 mm

Product Name	Motor Product Name	Gear Ratio	Mass kg	CAD
CRK523PAK-PS	PK523PA-PS	5, 7.2, 10	0.22	B684
CRK523PBK-PS	PK523PB-PS			

Motor lead wire/connector assembly (0.6 m) are included with the motor and driver package.

UL Style 3265, AWG 24

If you are purchasing only a motor for maintenance purposes, etc., motor lead wire/connector assembly and connector will not be supplied. Please provide separately. → Page 23

● Applicable Connector

Connector Housing: 51065-0500 (MOLEX)

Contact: 50212-8100 (MOLEX)

Crimp Tool: 57176-5000 (MOLEX)

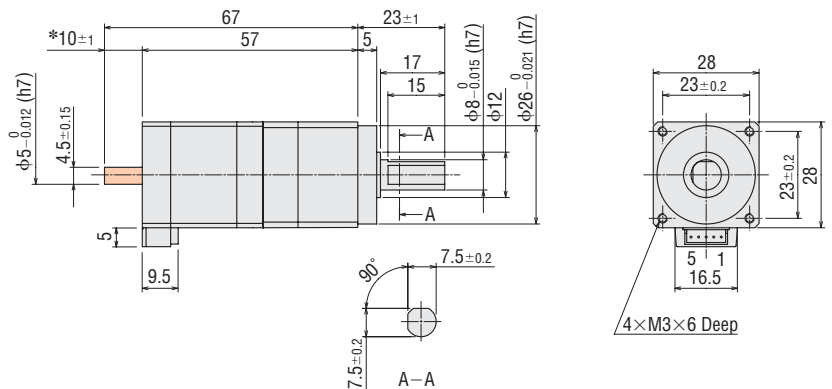

*The length of the shaft flat on the double shaft model is 10±0.25.

- A number indicating the gear ratio is entered where the box is located within the product name.
- These dimensions are for double shaft models. For single shaft models, ignore the areas.

◆ PS Geared Type

9 □ 42 mm

Product Name	Motor Product Name	Gear Ratio	L1	L2	Mass kg	CAD
CRK545AK-PS □	PK545AW-PS □	5, 7.2, 10	74.5	—	0.58	B678
CRK545BK-PS □	PK545BW-PS □			89.5		
CRK543AK-PS □	PK543AW-PS □	25, 36, 50	84	—	0.59	B679
CRK543BK-PS □	PK543BW-PS □			99		

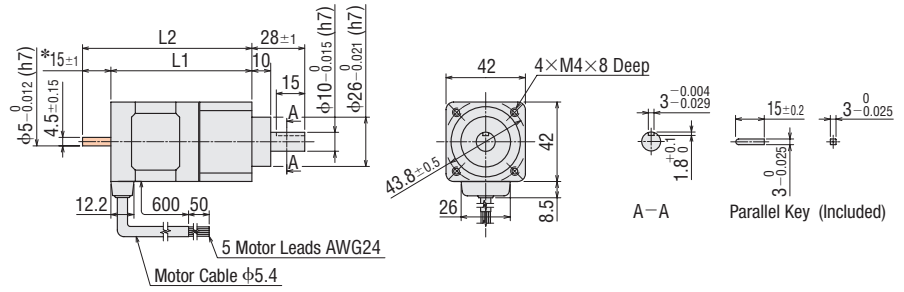

*The length of the shaft flat on the double shaft model is 15±0.25.

10 □ 60 mm

Product Name	Motor Product Name	Gear Ratio	L1	L2	Mass kg	CAD
CRK566AK-PS □	PK566AW-PS □	5, 7.2, 10	91.5	—	1.3	B685
CRK566BK-PS □	PK566BW-PS □			112.5		
CRK564AK-PS □	PK564AW-PS □	25, 36, 50	101	—	1.4	B686
CRK564BK-PS □	PK564BW-PS □			122		

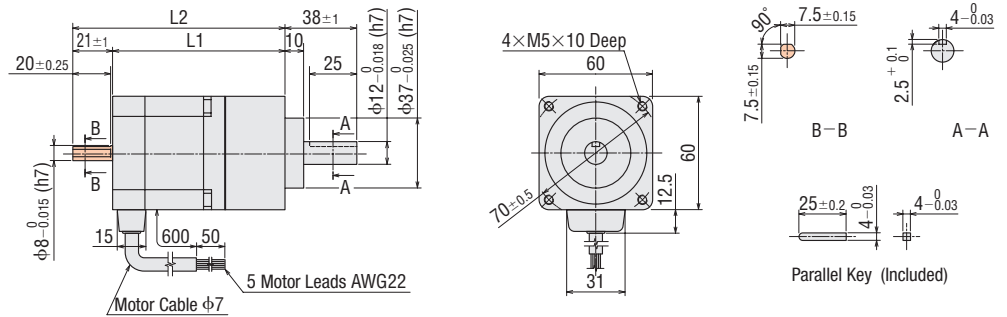

- A number indicating the gear ratio is entered where the box □ is located within the product name.
- These dimensions are for double shaft models. For single shaft models, ignore the □ areas.

● Drivers

11 Driver Product Name: CRD503-K, CRD507-K, CRD514-K

Mass: 0.12 kg

CAD B795

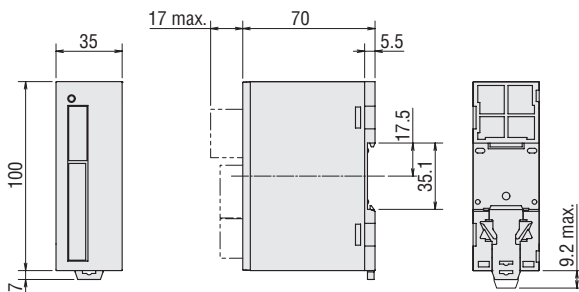

- Accessories
- Power connector (CN1)
Connector: MC 1,5/3-STF-3,5 (Phoenix Contact)
- Motor connector (CN2)
Connector: MC 1,5/5-STF-3,5 (Phoenix Contact)
- I/O signals connector
FK-MC 0,5/10-ST-2,5 (Phoenix Contact)

Connection and Operation

Names and Functions of Driver Parts

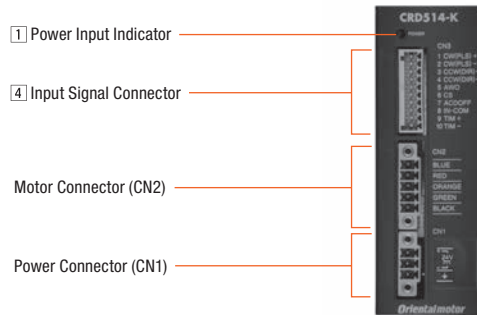
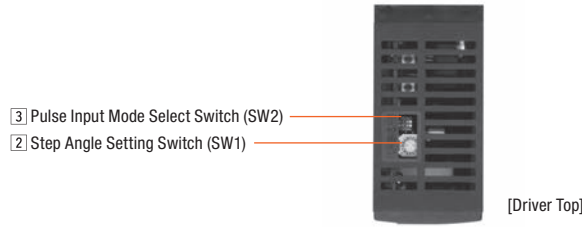

1 Signal Monitor Display

◇ LED Indicator

Color	Function	Lighting Condition
Green	Power supply indication	When the power supply is input

2 Step Angle Setting Switch (SW1)

Indication	Function
SW1	Each switch can be set to the desired step angle from the 16 levels of step angles.

SW1 Scale	Microsteps/Step	Resolution	Step Angle
0	1	500	0.72°
1	2	1,000	0.36°
2	2.5	1,250	0.288°
3	4	2,000	0.18°
4	5	2,500	0.144°
5	8	4,000	0.09°
6	10	5,000	0.072°
7	20	10,000	0.036°
8	25	12,500	0.0288°
9	40	20,000	0.018°
A	50	25,000	0.0144°
B	80	40,000	0.009°
C	100	50,000	0.0072°
D	125	62,500	0.00576°
E	200	100,000	0.0036°
F	250	125,000	0.00288°

Note

- The step angle is calculated by dividing the basic step angle by the resolution. The above figures are based on a basic step angle of 0.72°.
- If you are using a geared type, the actual step angle is calculated by dividing the step angle by the gear ratio.
- Do not change the Step Angle Select input signal or step angle setting switches while the motor is operating. It may cause the motor to misstep and stop.

3 Pulse Input Mode Select Switch (SW2)

Indication	Function
SW2	Switches the pulse input mode between 1-pulse input mode and 2-pulse input mode.

4 I/O Signals (CN3 10 Pin)

Indication	I/O	Pin No.	Code	Signal Name
CN3	Input	1	CW (PLS)+	CW pulse (pulse)
		2	CW (PLS)-	
		3	CCW (DIR)+	CCW pulse (rotation direction)
		4	CCW (DIR)-	
	Output	5	AWO	All windings off
		6	CS	Step angle select
		7	ACDOFF	Automatic current cutback release
		8	IN-COM	Input common
9		TIM+	Timing	
10		TIM-		

Connection Diagram

◇ When the Pulse Input is Line Driver

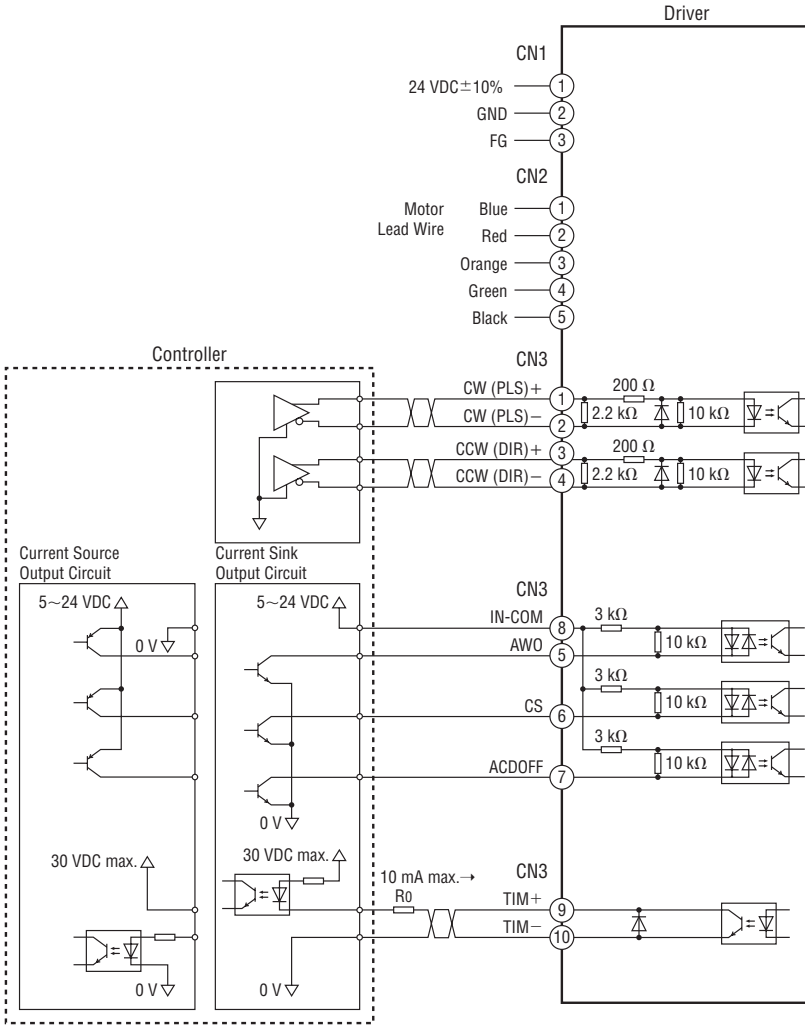

◇ When the Pulse Input is Open Collector

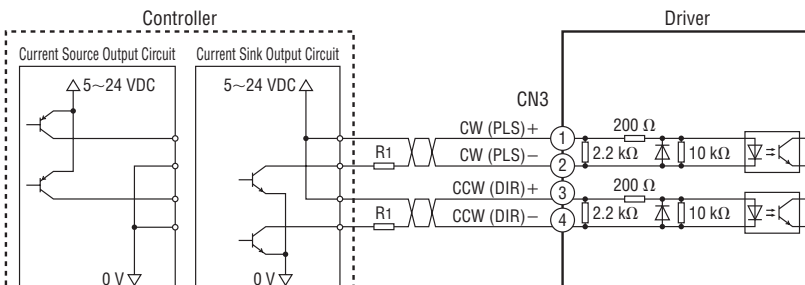

Notes on Wiring

◇ I/O Signal Connection

- Input Signal (When the pulse input is open collector)
The external resistor is not needed when the voltage is 5 VDC. If voltage exceeding 5 VDC is applied, connect an appropriate external resistor R_1 so that the current becomes 7 to 20 mA.
Example: When V_0 is 24 VDC, R_1 : 1.5 to 2.2 kΩ 0.5 W or more
- Output Signal
Check the specifications of all devices to be connected and if the current will exceed 10 mA, connect an external resistor R_0 .
- Use a twisted-pair wire of AWG26 to 20 (0.14 to 0.5 mm²).
- Since the maximum transmissible frequency drops as the pulse line becomes longer, keep the wiring length as short as possible (within 2 m).
- Provide a distance of 100 mm or more between the I/O signal lines and power lines (power supply lines, motor lines, etc.).

◇ Power Connection

- Use wires of AWG22 (0.3 mm²).
- Incorrect polarities of the DC power supply input will lead to driver damage. Make sure that the polarity is correct before turning power on.

◇ Extension of Motor Cable

- Use a wire of AWG22 (0.3 mm²) or thicker.

● Description of I/O Signals

Indication of I/O Signal ON and OFF

Input (output) "ON" indicates that the current is sent into the photocoupler (transistor) inside the driver. Input (output) "OFF" indicates that the current is not sent into the photocoupler (transistor) inside the driver. The input/output remains "OFF" if nothing is connected.

Photocoupler State: OFF ON

CW (Pulse) and CCW (The rotation direction) Pulse Input Signals

◇ Pulse Waveform

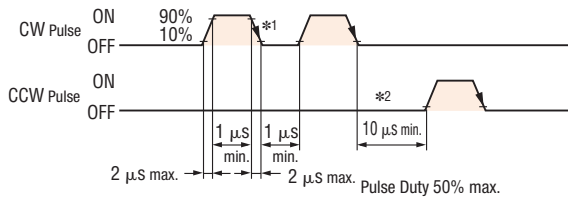

- *1 The shaded area indicates when the photocoupler diode is ON. The motor moves when the signal is switched from photocoupler "ON" to "OFF."
- *2 The minimum interval time 10 μs when changing rotation direction from CW to CCW is shown as a response time of the circuit. This value varies greatly depending on the motor type and load inertia.

◇ Pulse Signal Characteristics

- Keep the "Pulse" signal at photocoupler "OFF" when no pulses are being input.
- Do not turn a CW pulse and CCW pulse signal photocoupler "ON" simultaneously. (In the 2-pulse input mode).
- In 1-pulse input mode, leave the pulse signal at rest (photocoupler "OFF") when changing rotation directions.

All Windings Off (AWO)/Step Angle Switching (CS) /Current Cutback Release (ACDOFF) Input Signals

◇ All Windings Off (AWO) Input Signal

- This signal is used to put the motor in a non-excitation state (free).
- This signal is used when moving the motor shaft with an external force or manual positioning is desired. The photocoupler must be "OFF" when operating the motor.

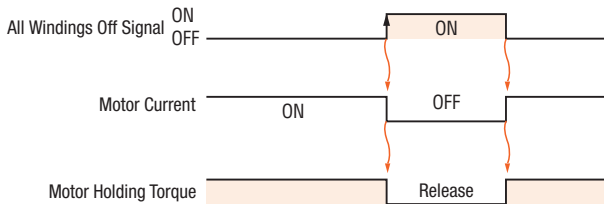

■ The colored area indicates that the motor provides holding force proportional to the current at motor standstill set by "STOP" potentiometer.

- The excitation sequence (phase) of the motor does not change even when the "All Windings Off" signal is switched from ON → OFF. However, the shaft may move within a range of up to ±3.6° (Geared type: ±3.6°/gear ratio).

◇ Step Angle Select (CS) Input Signal

- This signal allows for switching between the step angles set with the step angle setting switch (SW1).
- When the signal is photocoupler "OFF," the step angle set by SW1 is selected; when the signal is photocoupler "ON," the basic step angle is selected.

Example: Changing the step angle from 0.072° to 0.72° (basic step angle)

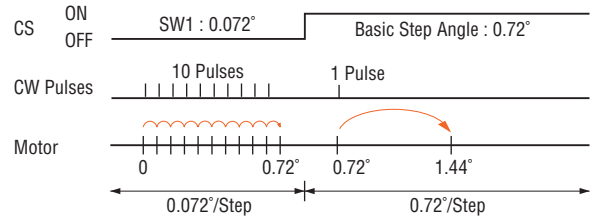

- Be sure to change "Step Angle Select" input signal only when the pulse signals are at rest. Switching while moving may cause a positional error of the motor.
- When the "Excitation Timing" signal is used, adjust the number of pulses so that the motor can operate with angles that are multiples of 7.2°. The "Excitation Timing" output signal may become impossible for some combinations of step angles.

Example: After moving 9 pulses with 0.072°/step setting, change the step angle to 0.72°/step and move 1 pulse. In this case, the "Excitation timing" signal will not be output because the step "0" position is skipped, as shown below.

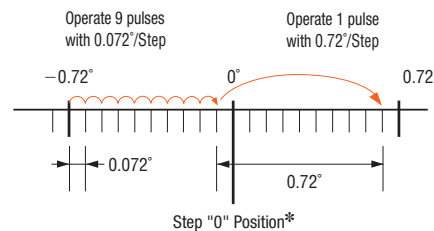

*The "Excitation Timing" signal is only output at step "0" position.

◇ Current Cutback Release (ACDOFF) Input Signal

- When the signal is "ON," the automatic current cutback function is disabled. When the signal is "OFF," the automatic current cutback function will be activated after the motor stops (after approximately 100 ms).

Excitation Timing (TIM) Output Signal

- The "Excitation Timing" signal is output to indicate when the motor excitation state is in the initial state (step "0" at power up).
 - The excitation state of the motor changes simultaneously with each pulse input and the excitation sequence returns to step "0" once the motor shaft has rotated by 7.2° (if the basic step angle of the motor is 0.72°). Accordingly, the "Excitation Timing" signal is output after every 7.2° rotation relative to step "0."
- Microsteps/Step 1: Signal is output once every 10 pulses
Microsteps/Step 10: Signal is output once every 100 pulses

Timing Chart at 0.72°/Step (Microsteps/step 1)

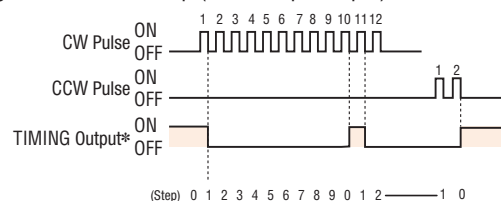

*When connected as shown in the connection example, the signal will become "ON" at step "0."

Note

- When power is turned ON, the excitation sequence is reset to step "0" and the "Excitation Timing" signal is output.

Timing Chart

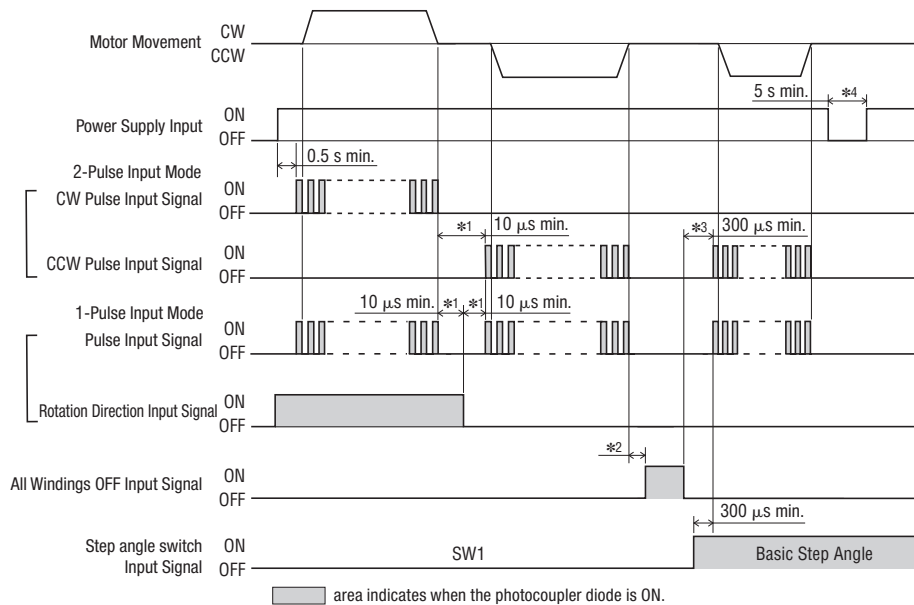

- *1 The switching time to change the CW, CCW pulse (2-pulse input mode) or switching time to change the rotation direction signal (1-pulse input mode) 10 μ s or more is shown as circuit response time. Set the time over which responding to the motor is possible.
- *2 Depends on load inertia, load torque and starting frequency.
- *3 Never input a pulse signal immediately after switching the "All Windings Off" signal to "photocoupler OFF." The motor may not start.
- *4 Wait at least 5 seconds before turning on the power again.

Motor and Driver Combinations

Product names for motor and driver combinations are shown below.

Type	Product Name	Motor Product Name	Driver Product Name
High-Torque Type	CRK513P □ K	PK513P□*	CRD503-K
	CRK523P □ K CRK525P □ K	PK523P□* PK525P□*	
Standard Type	CRK543 □ K CRK544 □ K CRK545 □ K	PK543N□W PK544N□W PK545N□W	CRD507-K
	CRK564 □ K CRK566 □ K CRK569 □ K	PK564N□W PK566N□W PK569N□W	CRD514-K
	CRK523P □ K-T7.2 CRK523P □ K-T10 CRK523P □ K-T20 CRK523P □ K-T30	PK523P□-T7.2* PK523P□-T10* PK523P□-T20* PK523P□-T30*	CRD503-K
TH Geared Type	CRK543 □ K-T3.6 CRK543 □ K-T7.2 CRK543 □ K-T10 CRK543 □ K-T20 CRK543 □ K-T30	PK543□W-T3.6 PK543□W-T7.2 PK543□W-T10 PK543□W-T20 PK543□W-T30	CRD507-K
	CRK564 □ K-T3.6 CRK564 □ K-T7.2 CRK564 □ K-T10 CRK564 □ K-T20 CRK564 □ K-T30	PK564□W-T3.6 PK564□W-T7.2 PK564□W-T10 PK564□W-T20 PK564□W-T30	CRD514-K

Type	Product Name	Motor Product Name	Driver Product Name
PS Geared Type	CRK523P □ K-PS5 CRK523P □ K-PS7 CRK523P □ K-PS10	PK523P□-PS5* PK523P□-PS7* PK523P□-PS10*	CRD503-K
	CRK545 □ K-PS5 CRK545 □ K-PS7 CRK545 □ K-PS10 CRK543 □ K-PS25 CRK543 □ K-PS36 CRK543 □ K-PS50	PK545□W-PS5 PK545□W-PS7 PK545□W-PS10 PK543□W-PS25 PK543□W-PS36 PK543□W-PS50	CRD507-K
	CRK566 □ K-PS5 CRK566 □ K-PS7 CRK566 □ K-PS10 CRK564 □ K-PS25 CRK564 □ K-PS36 CRK564 □ K-PS50	PK566□W-PS5 PK566□W-PS7 PK566□W-PS10 PK564□W-PS25 PK564□W-PS36 PK564□W-PS50	CRD514-K

● Either **A** or **B** indicating the motor shaft type is entered where the box □ is located within the product name.

*If you are purchasing only a motor for maintenance purposes, etc., motor lead wire/connector assembly and connector will not be supplied. Please provide separately. Motor lead wire/connector assembly and motor connector set are also available as accessories.

Motor lead wire/connector assembly → Page 23

Accessories (Sold separately)

Motor Lead Wire/Connector Assembly RoHS



Lead wires with a connector crimped for connector-coupled motors are available. This eliminates the need for assembling the lead wire and connector. (A motor lead wire/connector assembly (0.6 m) is included with the connector-coupled motor and driver package.)

Product Line

Product Name	Applicable Product	Applicable Motor Product Name	Length m	Conductor AWG
LC5N06A	CRK513P <input type="checkbox"/> K CRK52 <input type="checkbox"/> P <input type="checkbox"/> K CRK523P <input type="checkbox"/> K-T <input type="checkbox"/>	PK513P <input type="checkbox"/> PK52 <input type="checkbox"/> P <input type="checkbox"/> PK523P <input type="checkbox"/> -T <input type="checkbox"/>	0.6	24 (0.2mm ²)
LC5N10A	CRK523P <input type="checkbox"/> K-PS <input type="checkbox"/>	PK523P <input type="checkbox"/> -PS <input type="checkbox"/>	1	

- A number indicating the length of the motor case is entered where the box is located within the product name.
- Either **A** or **B** indicating the motor shaft configuration is entered where the box is located within the product name.
- A number indicating the gear ratio is entered where the box is located within the product name.

Flexible Couplings RoHS

Flexible couplings ideal for the **CRK** series are available. Once you have decided on a type and/or motor/gear application, you can easily select the recommended coupling size. All motor shaft diameters of the stepping motor packages are available (including geared motors).



Selecting a Coupling

Coupling Type	Motor Type		Application
	High Torque, Standard Type	TH Geared PS Geared	
MCV Coupling	◎	—	High positioning accuracy, vibration suppression
MC Coupling	◎	—	High positioning accuracy
MCS Coupling	○	◎	High strength and high positioning accuracy

Types and Features of Couplings

● **MCV** Coupling

This one-piece coupling is made with anti-vibration rubber molded between aluminum alloy hubs. Its high torsional rigidity and identical characteristics in forward and in reverse are ideal for stepping motor applications where high positioning accuracy is needed.

◇ Features

- The anti-vibration rubber absorbs vibration from the motor.
- High response.
- No backlash.
- Electrically insulated.

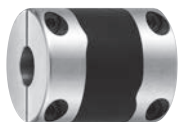

● **MC** Coupling

This is a slit-type one-piece coupling. Its high torsional rigidity and low inertia is ideal for applications where high-speed positioning and high response control are needed.

◇ Features

- No backlash.
- Torsional rigidity is high, responsiveness is excellent.
- Low-inertia.
- Set screw type and clamp type are available.



Set Screw Type



Clamp Type

● **MCS** Coupling

This three-piece coupling adopts an aluminum alloy hub and a resin spider. The simple construction ensures that the high torque generated by a geared type can be transmitted reliably.

◇ Features

- High strength enabling use with geared motors has been achieved.
- No backlash.



Motor Mounting Brackets RoHS

Mounting brackets are convenient for installation and securing stepping motors and geared type stepping motors.



Product Line

For High Torque, Standard Type

Material: Aluminum alloy

Product Name	Motor Frame Size	Applicable Product
PAFOP	42 mm	CRK54
PALOP		
PAL2P-5	60 mm	CRK56

- The mounting bracket base is built with holes large enough to allow for adjustments of belt tension after a motor is installed.
- These mounting brackets can be perfectly fitted to the pilot of stepping motors (excluding **PALOP**).

Note

- Not available for geared type.

For TH Geared Type

Material: Aluminum alloy

Product Name	Motor Frame Size	Applicable Product
SOLOB	42 mm	CRK54
SOL2A	60 mm	CRK56

- When installing **SOL2A**, use the included screws.
- Since screws are not included with **SOLOB**, prepare appropriate screws separately.

For PS Geared Type

Material: Iron

Surface Treatment: Electroless nickel plating

Product Name	Motor Frame Size	Applicable Product
PLA60G	60 mm	CRK56

- The mounting bracket base is built with holes large enough to allow for adjustments of belt tension after a motor is installed.
- The motor installation screws are included.

Clean Dampers RoHS

Mechanical dampers suppress stepping motor vibration and improve high-speed performance.

An inertia body and silicon gel are hermetically sealed in a plastic case.

Features

- Excellent Vibration Absorption
The doughnut-shaped internal inertia body and silicon gel absorb vibration. This feature enables a stable damping effect.
- Cleanness Support
No frictional dust means the clean damper can be used in environments where higher degrees of cleanliness are required.
- High Reliability
- The damper features high environmental resistance and deteriorates little with age because the silicon gel and plastic case are highly resistant to heat.
- The machine part is hermetically sealed in a plastic case. This ensures safety and prevents noise generation.
- The clean damper is specifically for use with double shaft types. Use with various double shaft type geared motors is possible.

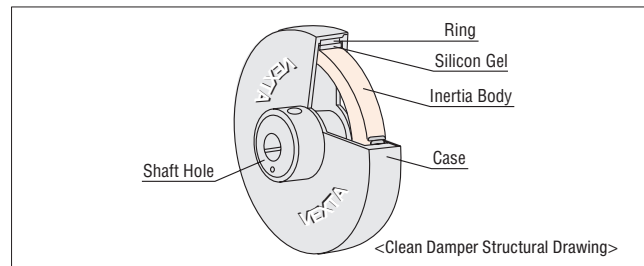

Product Line

Product Name	Inertia (kg·m ²)
D4CL-5.0F	38×10^{-7}
D6CL-8.0F	140×10^{-7}

Installation

Motor Installation

Motor Installation Direction

Motors can be installed freely in any direction as shown below. Regardless of how the motor is installed, take care not to apply an overhung load or thrust load on the shaft. Make sure the cable does not contact the installation surface causing undesirable force on the cable.

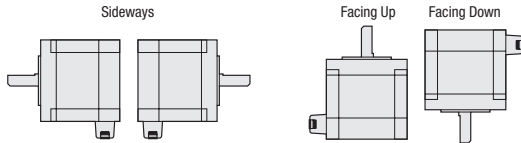

Note

- Do not disassemble the motors.
- Do not apply any shock to the motor.

Installation Methods

Considering heat radiation and vibration prevention as much as possible, install the motor tightly against a metal plane.

Installation Method for Through Hole Type

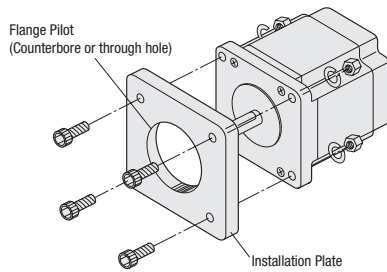

Installation Method for Tapped Hole Type

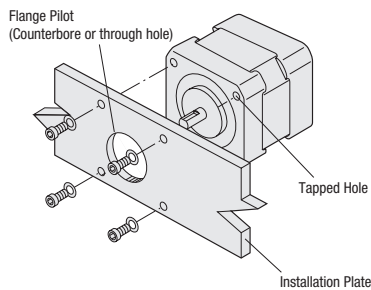

Installation Conditions

Install the motor in a location that meets the following general specifications. Use in a location that does not satisfy these conditions could damage the products.

- Indoors (This product is designed and manufactured to be installed within another device.)
- Ambient Temperature: -10 to $+50^{\circ}\text{C}$ (non-freezing)
- Ambient Humidity: 85% max. (non-condensing)
- Not exposed to explosive, flammable or corrosive gases
- Not exposed to direct sunlight
- Not exposed to dust
- Not exposed to water
- Not exposed to oil
- Place where heat can radiate easily
- Not exposed to continuous vibration or excessive shock

Note

- The ambient temperature will rise if located in an enclosed space such as a control box or close to a heat-radiating object. When installing the motor, make sure to use vent holes to prevent ambient temperature rise.
- Do not install the motor in a location where a vibration source is close and it will cause the motor to vibrate.

Driver Installation

Installation Direction

The driver is designed considering that there will be heat radiation through convection. Install the driver vertically as shown in the figure.



When Using Multiple Axes

There must be a clearance of 50 mm min. in both the horizontal and vertical directions between the driver itself and other devices or structures.

When installing 2 or more drivers in parallel, provide a clearance of 50 mm min. in the vertical direction between adjacent drivers.

Installation Methods

- Use DIN rails with a width of 35 mm.
- Use end plates to secure the driver.
- DIN rails and end plates are not provided.

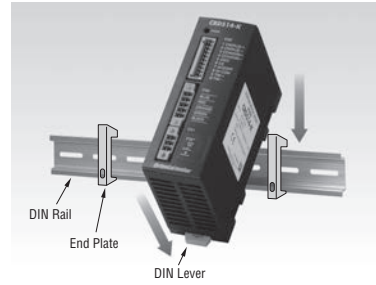

Installation Conditions

Install the driver in locations that meet the following conditions. Use in a location that does not satisfy these conditions could damage the products.

- Inside an enclosure installed indoors (with ventilation holes provided)
- Not exposed to an explosive atmosphere, toxic gases (sulfurized gas etc.) or liquids
- Not exposed to direct sunlight
- Not exposed to significant amounts of dust or iron dust
- Not exposed to water (rain, water droplets), oil (oil droplets) or other liquids
- Not exposed to air having high salt content
- Not exposed to continuous vibration or excessive shock
- Not subjected to significant electromagnetic noise caused by welders, power equipment, etc.
- Not exposed to radioactive materials, magnetic field or vacuum conditions

Controller (Sold separately)

Stepping Motor Controller

SG8030J RoHS



DIN Rail Installation Model



Recessed Installation Model

Feature

All operations including data setting can easily be performed using the 4 touch pads on the front panel. In addition, the number of signal lines is reduced to a minimum for easy operation and connection.

- Jerk Limiting Control Function for Suppressing Vibration of the Motor
- Sequential Positioning Operation and External Signal Operation Possible
- Maximum Oscillation Frequency 200 kHz
- 1-Pulse Output Signal/2-Pulse Output Signal Mode Select Possible

Product Line

Product Line	Product Name
DIN Rail Installation Model	SG8030J-D
Recessed Installation Model	SG8030J-U

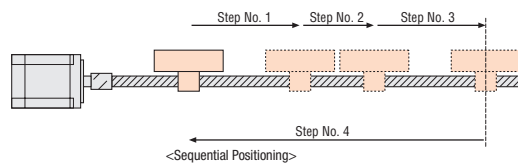

Orientalmotor

This product is manufactured at a plant certified with the international standards **ISO 9001** (for quality assurance) and **ISO 14001** (for systems of environmental management).

Specifications are subject to change without notice.
This catalogue was published in September, 2011.

SINGAPORE ORIENTAL MOTOR PTE LTD

31 Kaki Bukit Road 3, #04-02/04
TECHLINK, Singapore 417818
TEL: +65-6745-7344 FAX: +65-6745-9405
<http://www.orientalmotor.com.sg/>

ORIENTAL MOTOR (THAILAND) CO., LTD.

900, 8th Floor Zone C, Tonson Tower, Ploenchit Road,
Lumpini, Pathumwan, Bangkok 10330 Thailand
TEL: +66-2-251-1871 FAX: +66-2-251-1872
<http://www.orientalmotor.co.th/>

ORIENTAL MOTOR (MALAYSIA) SDN. BHD.

Headquarters & Kuala Lumpur Office
A-13-1, North Point Offices, Mid Valley City,
No.1 Medan Syed Putra Utara 59200
Kuala Lumpur, Malaysia
TEL: +60-3-22875778 FAX: +60-3-22875528
<http://www.orientalmotor.com.my/>

Penang Office

TEL: +60-4-6423788 FAX: +60-4-6425788

Johor Bahru Office

TEL: +60-7-3314257 FAX: +60-7-3314259

Customer Support Centre (Support in English & Chinese)

For Singapore: 1800-842 0280* * Free Call Mon-Fri: 09:00-17:30 Singapore Time
For Malaysia: 1800-806 161* * Free Call
For Other Countries: +65-6842-0280
Mail to: support@orientalmotor.com.sg

Japanese Customer Support Centre (Asia and Oceania Areas)

+65-6745-3008 Mon-Fri: 09:00-17:30 Singapore Time
Mail to: j-support@orientalmotor.com.sg

For more information please contact: